



Department of Energy
Richland Operations Office
P.O. Box 550
Richland, Washington 99352
JAN 17 1996

96-PAD-63684

Mr. Ralph Arcaro
DNFSB Technical Staff
625 Indiana Avenue, N.W.
Suite 700
Washington, D.C. 20004

Dear Mr. Arcaro:

TANK WASTE REMEDIATION SYSTEM PRIVATIZATION

Attached is a note from Mr. Don Vieth which transmits to you a copy of a briefing package used for discussions with representatives of the Nuclear Regulatory Commission. The discussions focused on Tank Waste Remediation System (TWRS) privatization. If additional assistance or more information is desired, you may contact me at (509) 376-1890, or contact Mr. Vieth, TWRS, at (509) 373-9189.

Sincerely,

A handwritten signature in cursive script that reads "S. L. Trine".

S. L. Trine, RL/DNFSB Liaison
Performance Assessment Division

PAD:SLT

Enclosure

cc w/ encl:
D. Gupta, EM-38
M. A. Mikolanis, EH-9
J. C. Tseng, EM-4
M. B. Whitaker, EH-9
L. M. Morgan, PAI

December 26, 1995

To: Ralph Arcaro

Subject: Copy of Briefing Package used with NRC

One of the issues we are dealing with is who should provide for the radiological and nuclear safety regulation of the TWRS privatized vendors processing the high-level waste. The position outlined in the Draft RFP is that DOE/RL will do it. There is consideration now by the top management of the NRC, the Chairman of the Commission, encouraged by the Secretary of Energy and the Assistant Secretary for ES&H, to have NRC take over the regulation of Phase I.

We had a meeting with Jim Taylor and Hugh Thompson pursuant to their expressing interest and provided a detailed briefing of the situation to help them understand the full ramifications of what they will be getting into. Attached per your request is a copy of the briefing package we used.

The staff, under Carl Paperiello's direction has been considering the issue for the NRC. I understand that a paper (SECY - ?) has been prepared and sent forward on Thursday or Friday of last week. You might want to get a copy. As I remember, the rule governing the availability of these papers, is, they are public documents and become available after the Commissioners have about 5 days to review the material.

If you have any questions about the material, please let me know.

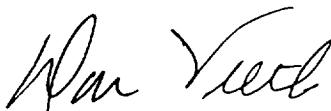

Don Vieth

c.c. John Tseng (w/o encl)
Densesh Gupta (w/o encl)
Sandy Trine (w/o encl)
Mike Micholinas (w/o encl)

Hanford Tank Waste Remediation System Privatization

Briefing for
Hugh Thompson
Deputy Executive Director
for Nuclear Materials Safety, Safeguards and
Operations Support
December 4, 1995

by
Dr. Donald L. Vieth,
Senior Technical Advisor TWRS Program
Richland Operations Office
U.S. Department of Energy

TWRS Privatization - Outline of Briefing

- 1 General background on Hanford tank situation
- 2 Tank Waste Remediation System
- 3 Concept of Privatization
- 4 Motivation Factors behind Privatization
- 5 Potential Benefit of Privatization
- 6 Feasibility of Privatization TWRS
- 7 Procurement Process for Privatization Operations of TWRS
- 8 Schedule Implementation and Demands
- 9 Radiological and Nuclear Safety Regulation Requirements

Overall Perspective of TWRS- Hanford Tank Waste Situation

- 7 Tank farms in 200 West area (83 Single-shell, 3 Double-shell tanks)
- 11 Tank farms in 200 East area (66 Single-shell, 25 Double-shell tanks)
- 149 Single-shell tanks (150 MCi/180,000MT of solids)
- 28 Double-shell tanks (92 MCi/50,000 MT of solids)
- 1,948 Capsules of SrF₂ and CsCl₂ (150 MCi)
- 52 Tanks of "Watch List" (46 Single-shell, 6 Double-shell tanks)
 - 20 Ferrocyanide tanks (1 Kg-mole)
 - 25 Hydrogen/flammable gas tanks
 - 10 Organic constituents tanks
 - 1 High-heat Tank
- 57 Assumed leakers

Tank Ages, Factor Potential Risks

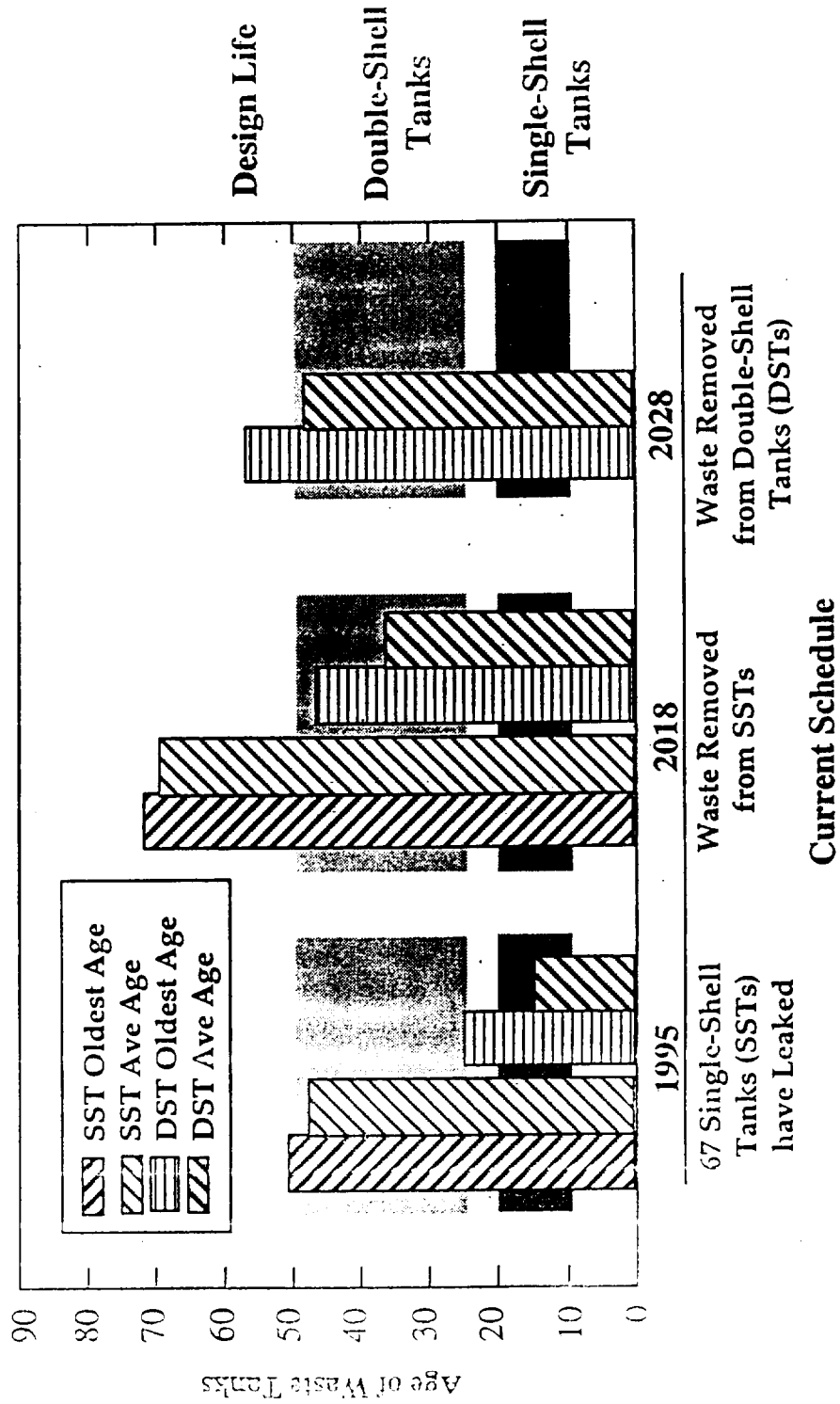



TWRS Privatization

6994S11/27-5

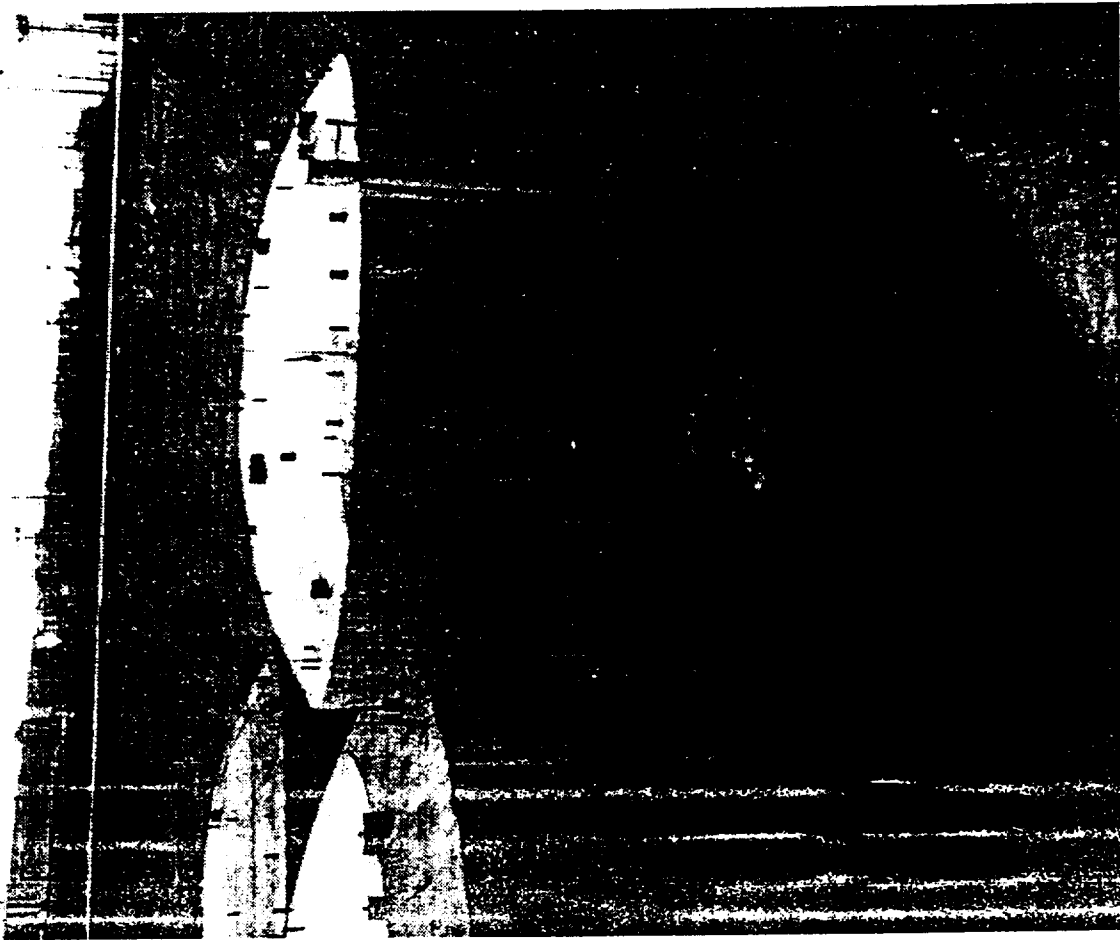

TWRS Privatization

699/SS11/27-6

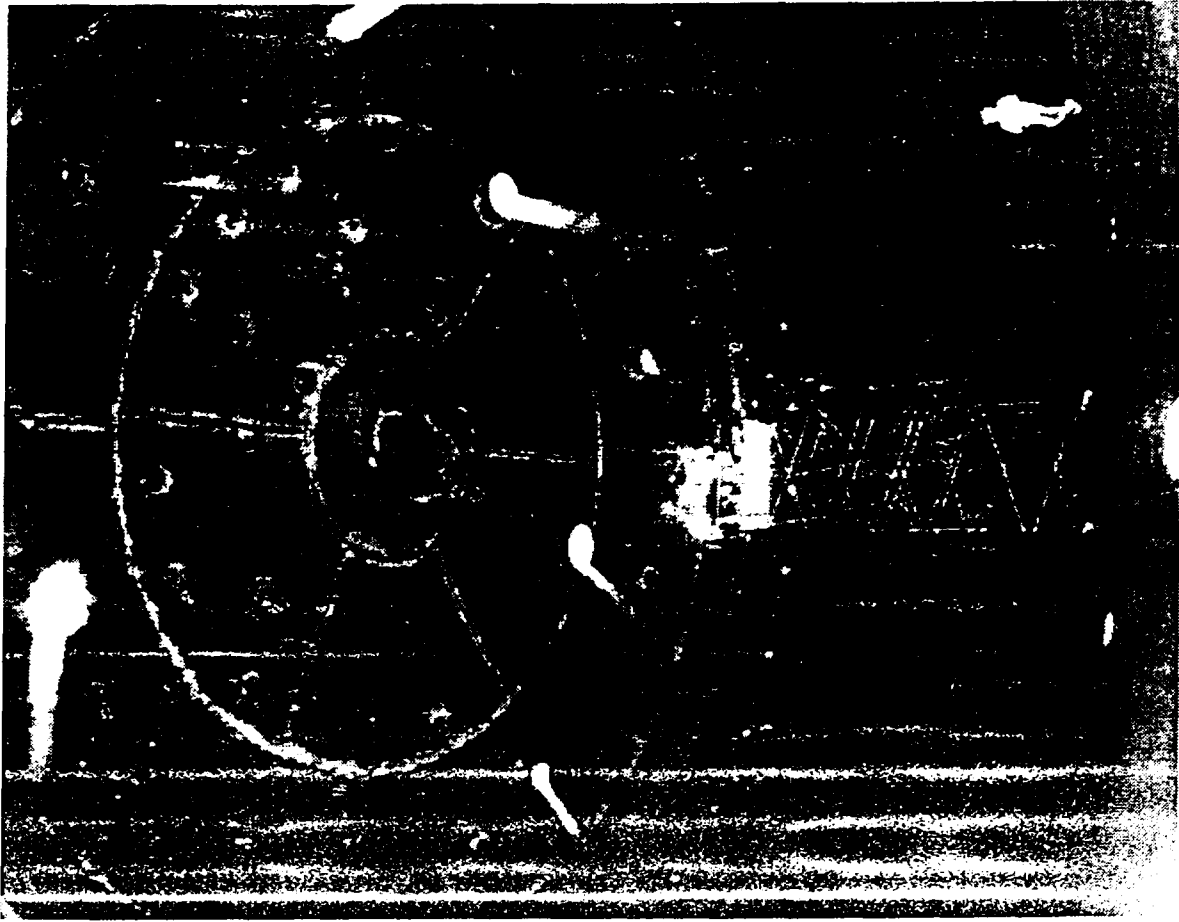

T VRS Privatization

6994SS11/27-7

TWRS Program Facilities

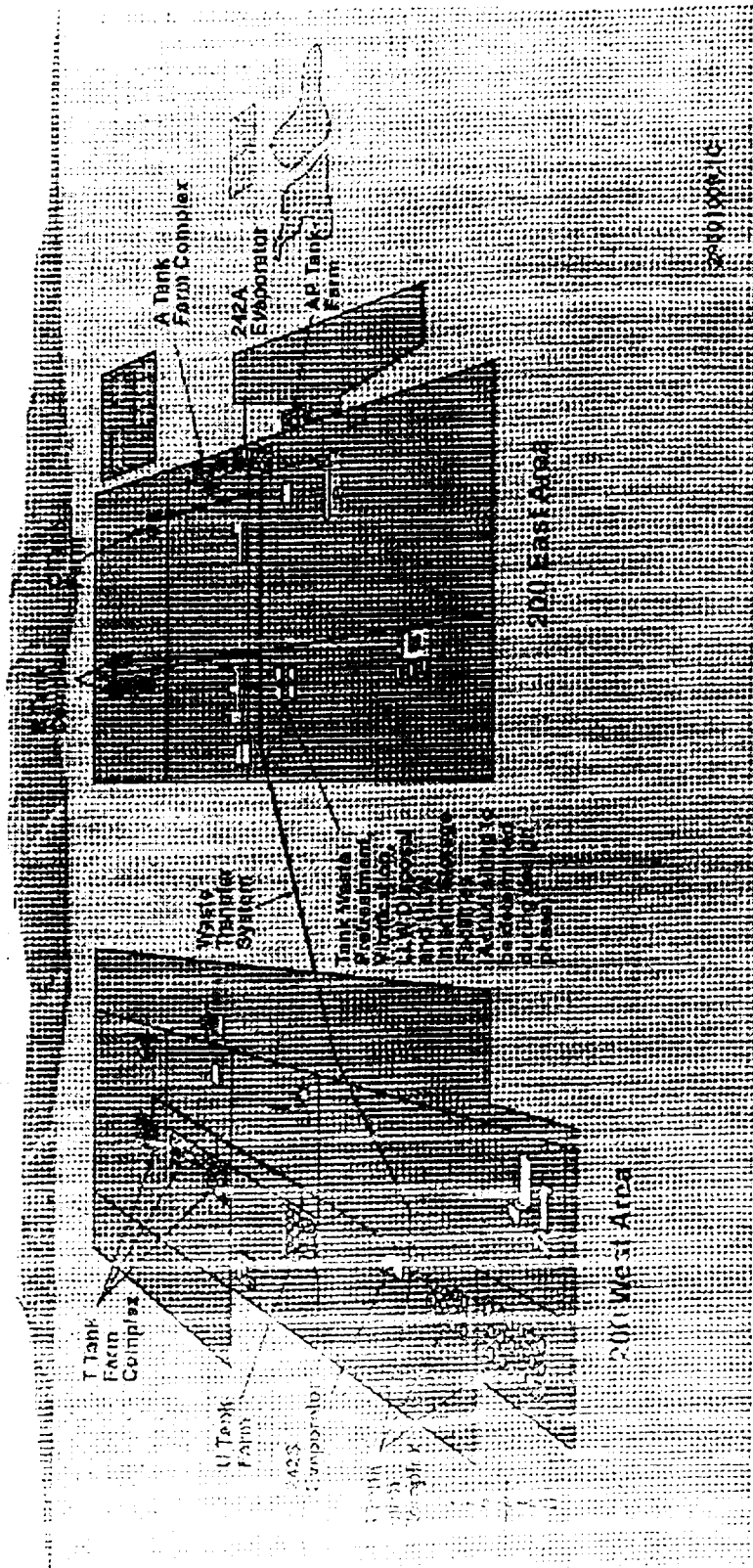

TWRS Privatization

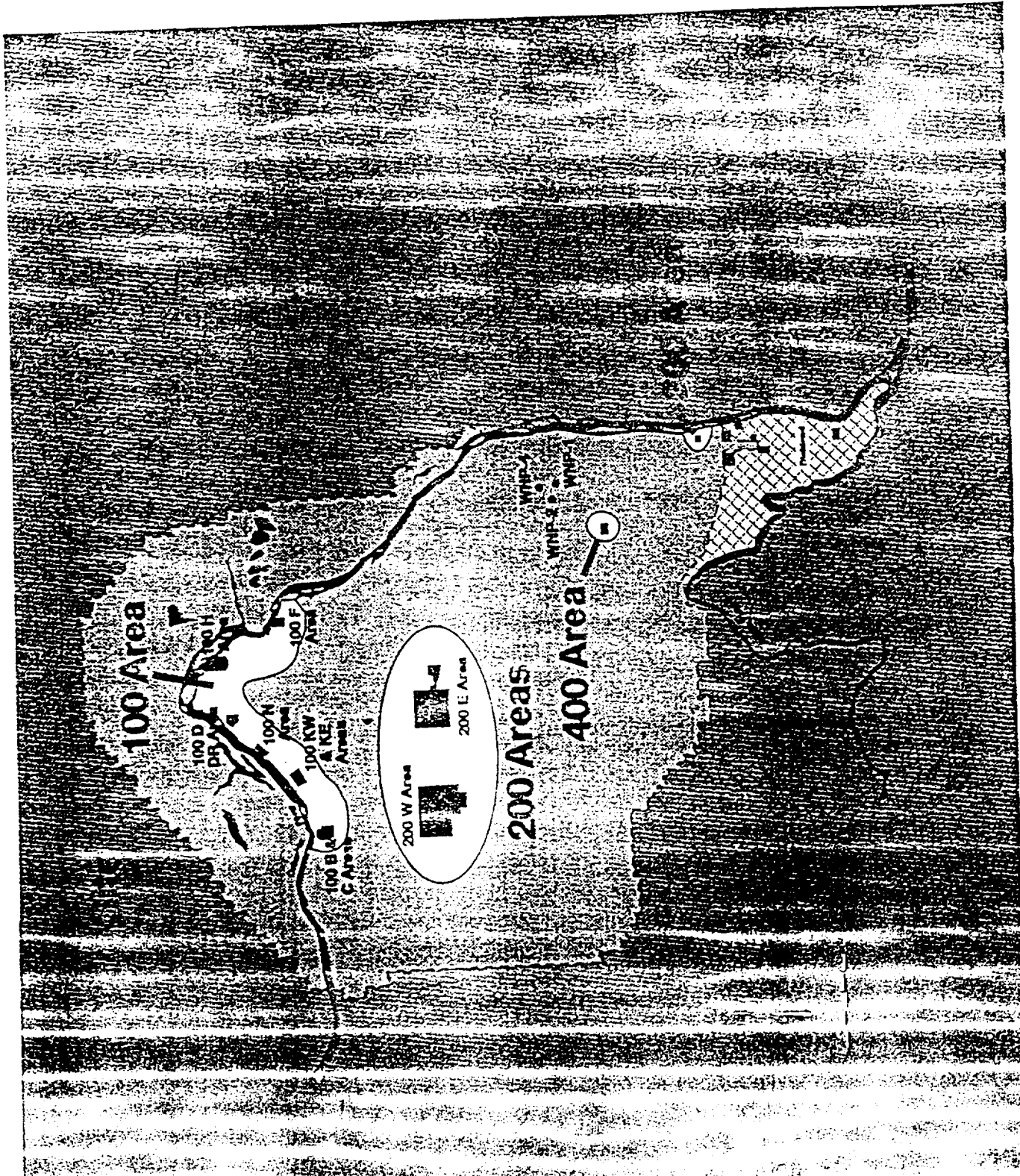

Tank Waste Remediation System (TWRS) Program Mission

The mission of the TWRS Program is to manage, retrieve, treat, immobilize and dispose of highly radioactive tank waste in a safe, environmentally sound, and cost-effective manner.

The Program's prime responsibility is to conceive, develop, design, construct and operate the physical system to retrieve and process the waste to convert it into durable solids suitable for disposal.

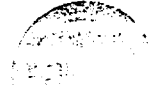

Schematic Diagram - Tank Waste Remediation System

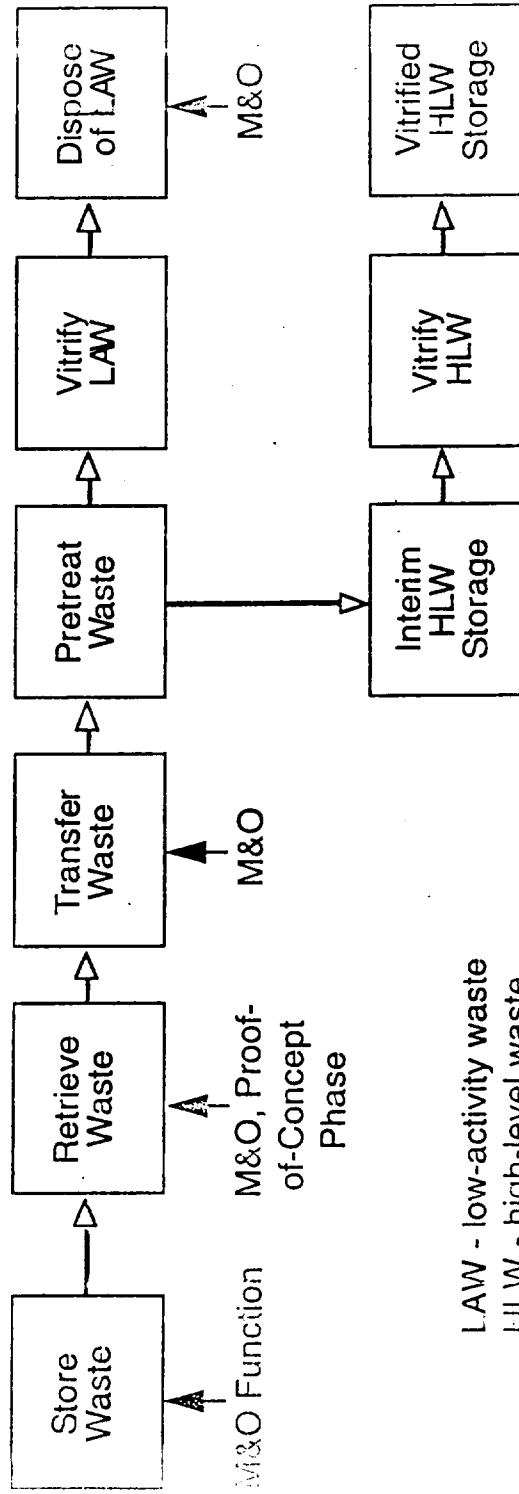

TWRS - What is in the Tanks

Liquids

Supernatant

(soluble salts plus sufficient water to make solution)

Solids

Saltcake

(Soluble salts without sufficient water to make a solution)

Sludges (~7% of mass of process chemicals)

(insoluble compounds which must be slurried)

TWRS - Mass Processing Considerations

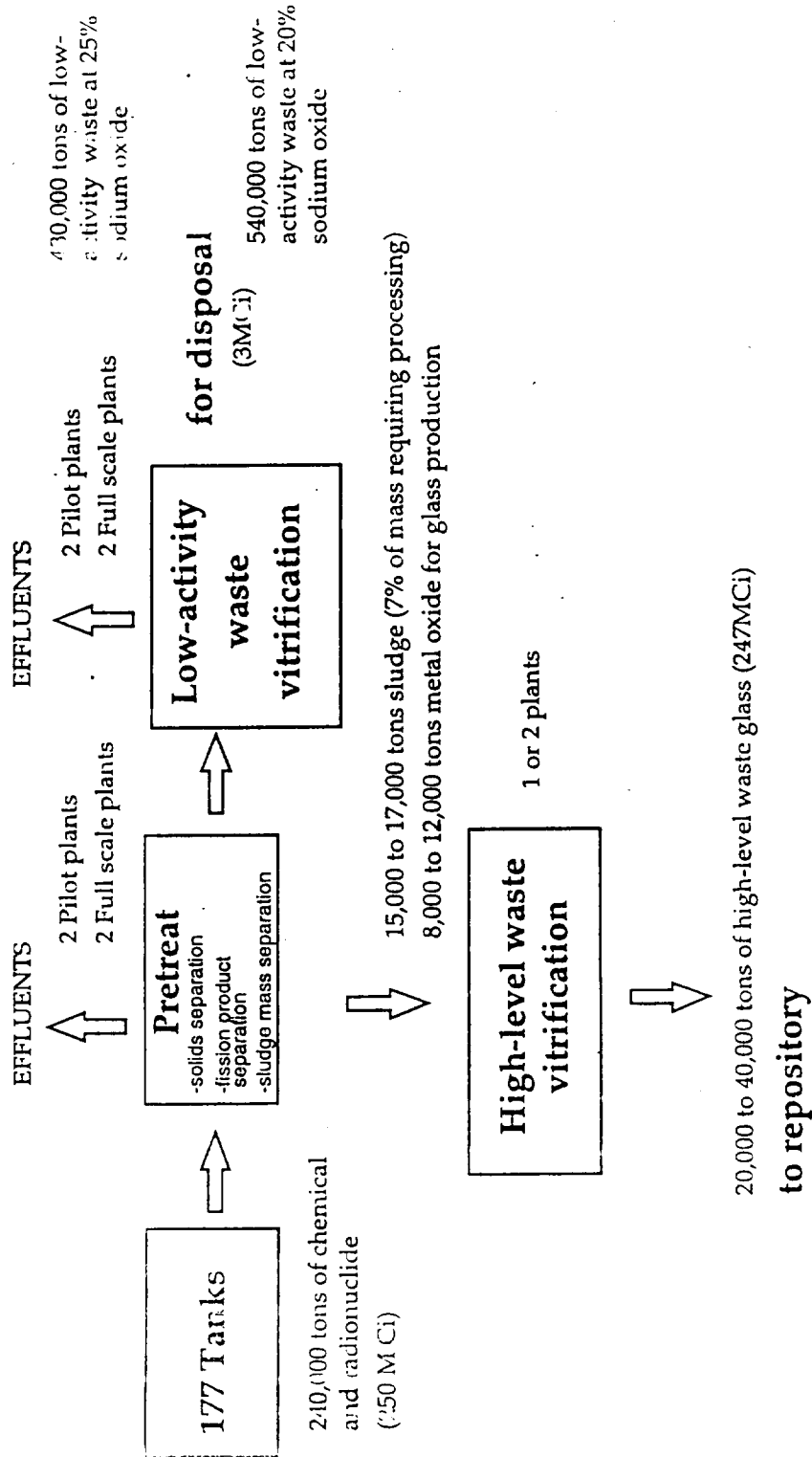

TWRS - Important Technical Parameters

Waste Chemistry

Cations		Anions	
Na	68270 MT	NO ₃	110000 MT
Al	4840 MT	OH	12980 MT
P	1880 MT	NO ₂	10560 MT
Fe	819 MT	CO ₃	2730 MT
Si	506 MT	F	1166 MT
Cr	165 MT	Cl	486 MT

Point: sodium will dominate the production of low-activity waste
release of NO_x will create a signification requirement for emissions control

TWRS: Important Technical Parameters

Soda Glass Leaching

<u>Percent Soda % Na₂O</u>	<u>Performance Measure Leach Rate (Na g/m₂/week)</u>
15	0.15
20	0.4
25	1.5
30	6.0
35	35.0

Higher soda content, smaller amount of waste, lower total cost but poorer performance

Lower soda content, better performance, larger amount of waste but higher cost (if unit price is based on mass of solid waste)

Focus on Privatization- Definitions of Privatization

Classical Definition

- The Government, which runs a major service operations that services large client populations, sells the operations to a private sector organization so they can provide this service. The Government allows the market forces to define the price, nature, and quality of the service.

TWRS Definition

- Vendors, under contract with the Department of Energy (DOE), to provide a service use private funding to design, permit, construct, operate, decontaminate and decommission their own equipment and facilities to treat tank waste, and receive payment when producing products meeting DOE's performance specifications.

Requirements for TWRS Privatization

Ownership of facilities, processes and technology by vendor

Deliverables purchased against a quantifiable/measurable specification

Note: Must be done within business framework that provides for continuous competition



TWRS Privatization



Two Phased Structure of TWRS Privatization

Proof-of-Concept phase (Phase I)

Full-Scale production phase (Phase II)



Concept of Phased Approach TWRS Privatization

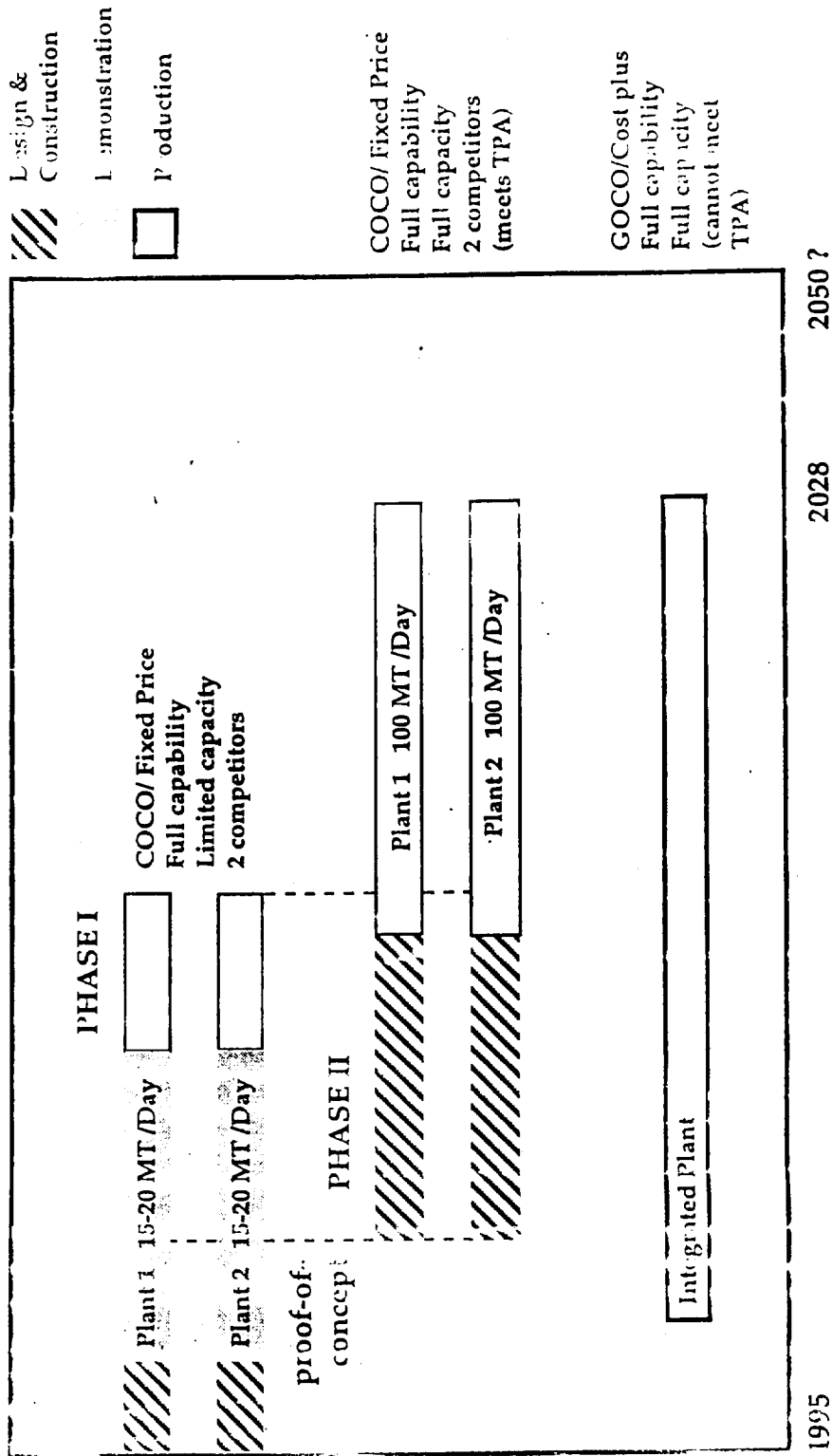

Reference
Privatization
1995

Report
Baseline
M&C

TWRS Privatization

Tank Waste Remediation System Privatization Approach

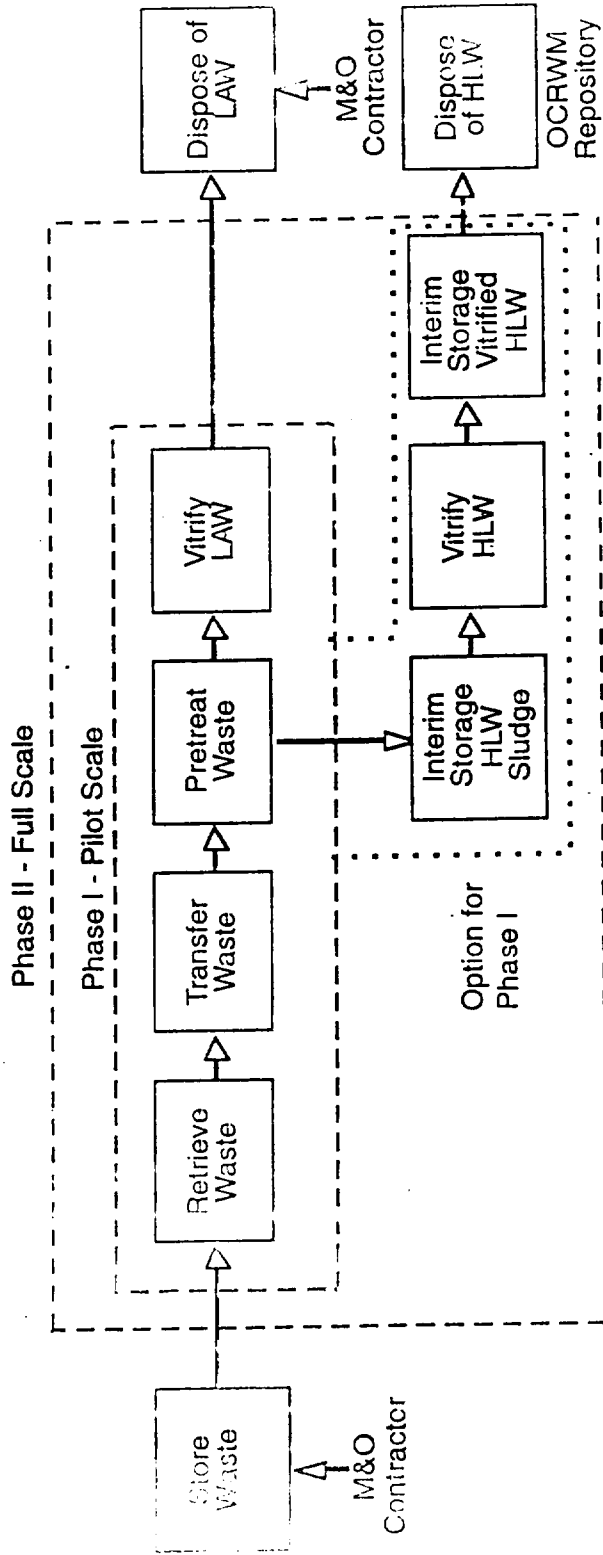

Assurance of a Competitive Framework

- Two waste process lines operating simultaneously
- Two vendors operating process lines / facilities

Note: Basis for maintaining continuous competition

Development of Strategy- Objectives of TWRS Privatization

- ▣ Reduction of total cost of achieving tank waste remediation
- ▣ Improvement on schedule
- ▣ Improvement in quality of interim and final products

Summary of Motivating Factors

- Vice President Gore's initiative to reinvent government
- DOE Contract Reform Initiative
- Private Industry's approach to the Department of Energy
- Budgets continuing to decline (not bottomed out yet)
- Cost of Baseline Program
 - Tri-Party Agreement Case Beta cost estimated at \$36B
 - Program estimate \$40B

Changes in the American Condition

- Escalating Federal Deficit
- Escalating Cost of Government
- Subsequent Changes—and still a dynamic situation
- Theme of Change



Contract Reform Initiative Task Force Recommendations

- Pay for performance
- Fixed Price contracting
- Build versus Buy alternative
- Tiered Fee structure
- Incentive Fees
- Privatize "Routine Operations"

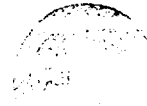

Genesis of Privatization Review of TWRS

- ECA concept to privatize the High-Level Waste Vitrification Plant (Summer 1993)
- Evaluation Requirements codified as TPA milestone (M-51-01-T01)
- Implication: Private company, willing to finance and take on responsibilities to fulfill commitments in Hanford Federal Facility Agreement and Consent Order
- Outcome: Evaluate Privatization of TWRS

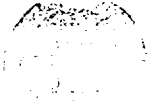

Principles Embedded in TWRS Privatization

- 1 Fulfill TPA commitments
- 2 Shifts significant responsibility, accountability, and liability to vendor
- 3 Makes vendor responsible and accountable for cost and technical performance
- 4 Plant/operation, vendor owned, vendor operated
- 5 Vendor responsible for environmental protection/compliance
- 6 No reduction to worker/general public safety/health protection
- 7 Government purchases products/services against performance specifications
- 8 Acquisition of products/services under fixed price contract
- 9 Establish competitive framework for cost control
- 10 Reduction of life cycle cost
- 11 PI based learning/continuous improvements starting with pilot plants
- 12 Vendors own sufficient technology; Department focus on high risk, potentially high payoff technology development

Logic in Making a Decision to Privatize TWRS

Approach to evaluation

- Feasibility
- Desirability

Concept of Feasibility

Is it possible to successfully - privatize TWRS?

From the big picture, are there any major hurdles that are clear show stoppers to the effort?

Concept of Desirability

Will we really benefit if we successfully execute this effort?

Do we really understand all the details that have to be addressed and can they be accomplished in a fashion that makes the effort effective?

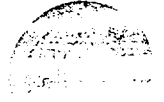

Basis for Feasibility Determination

- Factors considered
 - TPA Schedule
 - Regulatory Framework
 - Financiability
 - Budget/Funding
 - Cost
 - Vendor Interest
 - Performance Specification
 - Definition of waste feedstock
 - Technical implementation
 - Definition of Objectives

Evaluate both phases

Used "Reference System" as a basis for evaluation

Bottom line - it is *feasible* to privatize TWRS but it will be a challenge to meet all the boundary conditions

TWRS Privatization Fundamental Concepts Considered

Option 1

Elementary system with maximum flexibility in terms of facility configuration to handle wide variety of currently ill-defined process situations and requirements

Option 2

Progressively tailored chemical processing campaigns in modular distributed units based upon good knowledge and technical understanding of waste

Reference System used to Evaluate Feasibility

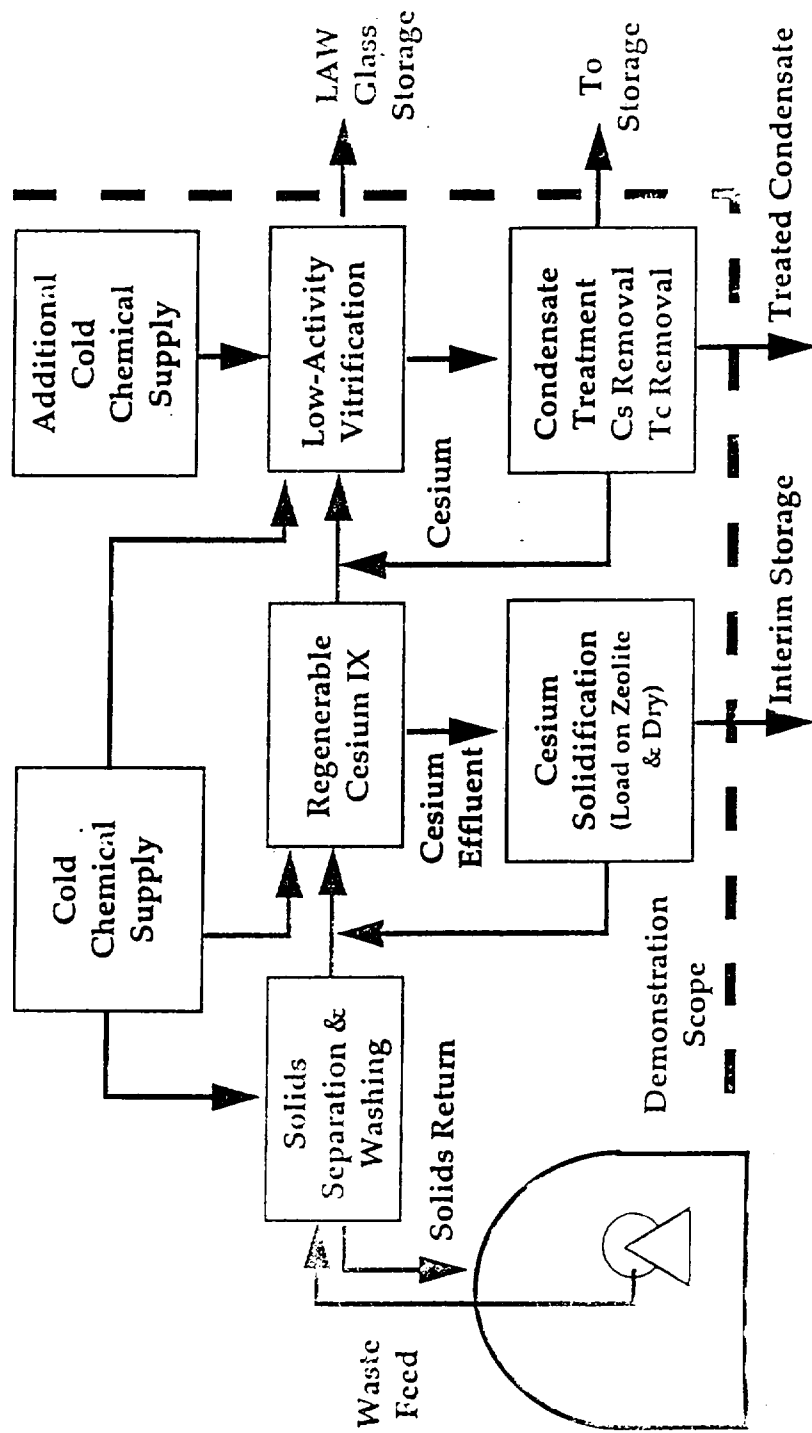

NEPA Requirements

NEPA review must be complete before implementing action but is not required to initiate the procurement process

The Department is looking at two primary paths to provide NEPA coverage for the proposed privatization

- Perform a supplement analysis to determine whether the action is covered by the 1987 Hanford Defense Waste (HDW) EIS or whether a supplemental HDW EIS is needed
- Accelerate the schedule for the TWRS EIS which is already in preparation, and assure that it provides the NEPA coverage

NEPA Record of Decision would be required prior to contract award



Tri-Party Agreement Requirements

Meeting the Department's Long-term commitments is the most critical concern

• Benchmark milestones used to evaluate ability to meet Department's Long-term commitments

Start hot operations of LAW pretreatment facility to remove Cs and Sr	12/31/04
Initiate hot operations of the LAW vitrification facility	06/30/05
Start hot operations of HLW pretreatment facility	06/30/08
Initiate hot operations of HLW vitrification facility	12/31/09
Retrieve waste from all SSTs	09/30/18
Complete closure of SST Farms	09/30/24
Complete pretreatment processing of Hanford tank waste	12/31/28
Complete vitrification of HLW	12/31/28
Complete vitrification of LLW	12/31/28



Vendor Interest

- 1 Most vendors support privatization but express concern with implementation
- 2 Recommendation that DOE hire expert financial, legal and systems engineering advisors to ensure privatization success
- 3 Most vendors indicated it was critical that the federal government ensured funds would be available and are adequate to cover costs
- 4 Most vendors accepted the Tri-Party Agreement as a constraint
- 5 *Many vendors consider regulatory uncertainties a major risk in terms of potential delays unacceptable to financiers*

Financial Requirements

- 1. Hired financial advisor
- 2. Privatization of TWRS is potentially feasible if DOE can
 - o Define the product it ultimately wants to buy
 - o Define the tank waste stream within reasonable bounds
 - o *Define the regulatory framework in which the facilities will be designed, built, operated, decontaminated, and decommissioned*
 - o Define the treated waste product performance specifications and empty tank standard
 - o Financially guarantee that if DOE terminates the contract, invested capital with some profit is paid to the vendor

Regulatory Framework

Three components of regulatory oversight

- Environmental Protection & Compliance
Standard Washington State permitting requirements
- Occupational Safety and Health
Federal Agency - Occupational Safety & Health Administration
State Agency - Washington Industrial Safety & Health Administration
- Radiological Safety
Committee on External Regulation of DOE Nuclear Facilities
Phase I: Department of Energy-Regulation
Phase II: Nuclear Regulatory Commission Regulation

Definition of Objectives

Full-Scale Production Phase

- Complete remediation within TPA schedule or sooner
- Accomplish task in economical manner
(below current estimated cost for baseline)

• Vendor's objectives still to be defined

Proof-of-Concept/Commercial Demonstration Scale Phase

• Vendor's objectives still to be defined

- Learn/demonstrate capabilities

• Department's objectives

- Learn how to make privatization work
- General objectives
- Technical objectives
- Procurement objectives
- Cost objectives

Objectives for Proof-of-Concept

- General
 - Establish confidence that TPA milestones can be achieved
 - Demonstrated there is a commercially viable business
- Technical
 - Demonstrate production throughput, process efficiency and radionuclide removal
 - Understand and overcome unanticipated problems
- Procurement
 - Establish conditions sufficient to write good contracts for Phase II
- Cost
 - Develop pricing for deliverables
 - Understand framework to keep costs down



Objectives for Proof-of-Concept Specific Technical Objectives

- Name-plate production capacity test
- Solid/liquid separation
- Fission production removal efficiency
- TRU removal
- Effects of organics on operations

Basic Concept for Initiating TWRS Privatization (Phase I)

- Competitive solicitation for two contractors owned, contractor operated services (including facilities) to process and deliver solidified low-activity waste (high-level waste processing maintained as an option)
- Divide Phase I into two stages
 - Design, radiological safety review, permitting
 - Construction/Operations
- Make pre-determined capital payment to each contractor when design and radiological safety reviews are completed
- Critical factor in evaluating proposals
 - Fixed price cost for design of facilities
 - Fixed price cost for delivery of products (final and interim)
 - Adjustment (downward) of fixed price cost for delivery of products at completion of design

Basic Concept for Initiating TWRS Privatization (continued)

- Hold contractors responsible for technical/cost performance and pay only for treated waste products meeting contract performance/product specifications, once plant begins operation



Proof-of-Concept Phase- General Concept

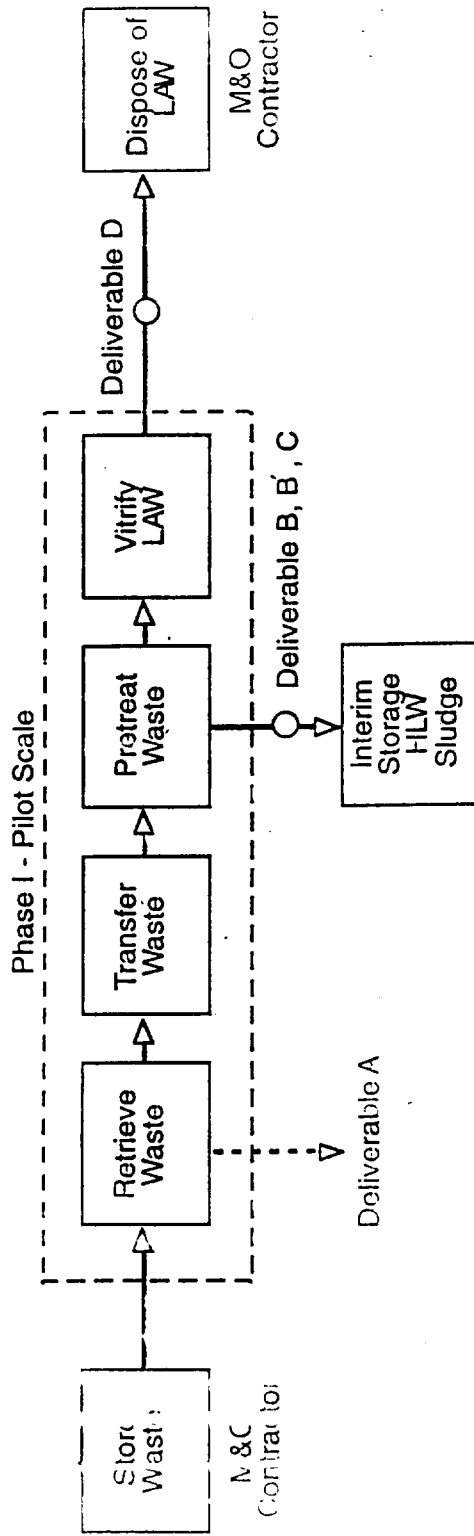

- Deliverable A= Empty tanks that meet TPA defined requirement
- Deliverable B = Separated high-level waste sludge for interim storage
- Deliverable B' = Separated and pretreated high-level waste sludge ready for vitrification
- Deliverable C= Separated fission products suitable for intermediate term storage with the option for high-level waste vitrification
- Deliverable D= Vitrified low-activity waste that meets DOE performance/product specifications

Proof-of-Concept Phase-Impact of Limited Funding on Scope of Effort

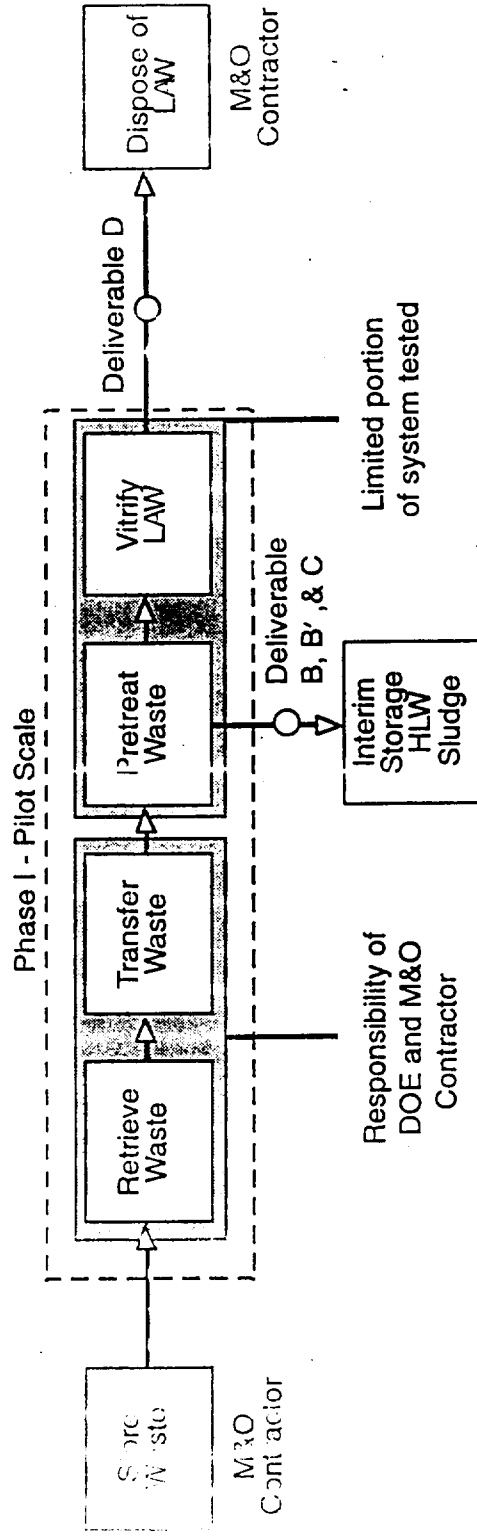

- Deliverable B = Separated high-level waste sludge for interim storage
- Deliverable B' = Separated and pretreated high-level waste sludge ready for vitrification
- Deliverable C = Separated fission products suitable for intermediate term storage with the option for high-level waste vitrification
- Deliverable D = Vitrified low-activity waste that meets DOE performance/product specifications

Critical Financial Parameter

- In Initial Proposal
 - Not to Exceed Price
- At 3 to 2 Downselect
 - Firm Fixed Price

Note: Need to have regulatory uncertainties minimized to get best price

Schedule - Near Term: Privatization Execution for Phase I

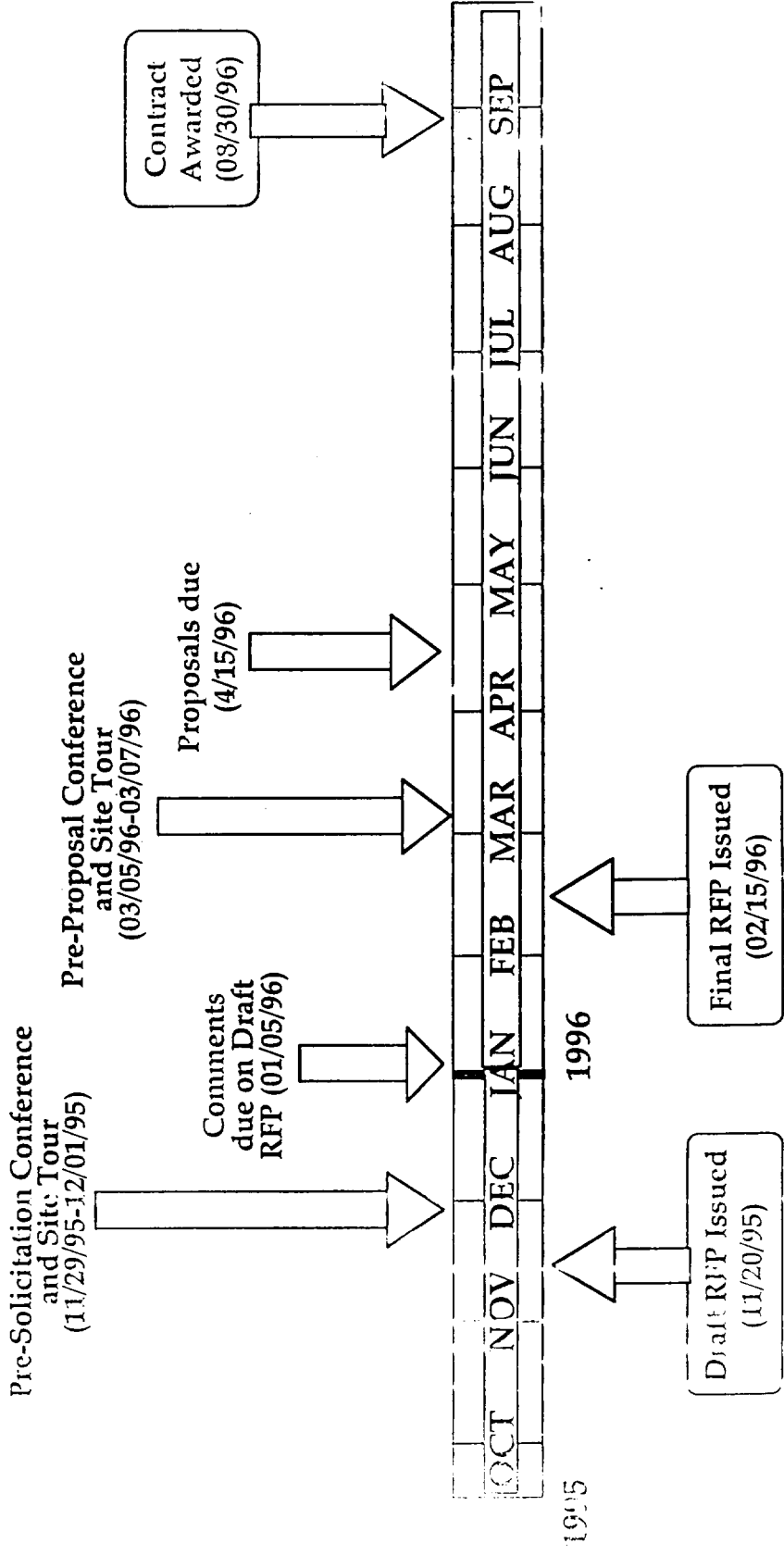

Schedule - Long Term: Privatization Execution for Phase I

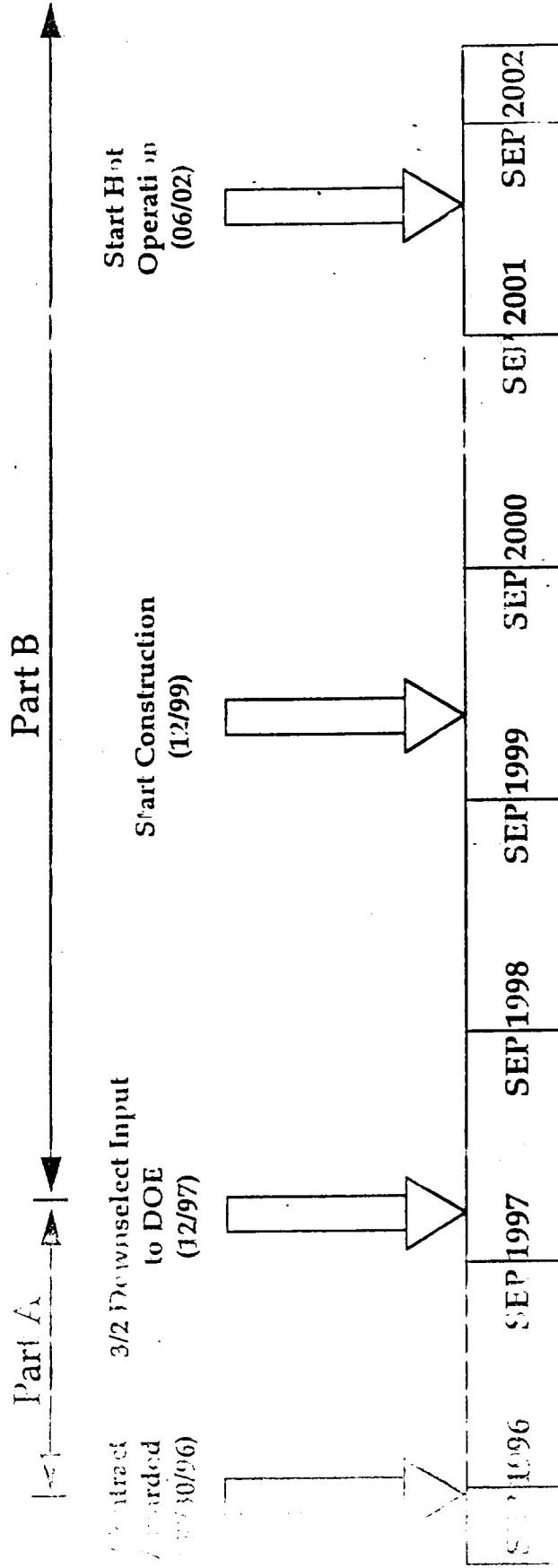

Ecological and Nuclear Safety: General Situation

- High-level radioactive waste being processed; commercial market operation would have to be licensed by NRC
- Technology and processes to be proposed to handle waste not fully revealed to DOE by potential contractor
- Need to remain flexible to accommodate new technology and processes
- DOE not likely to know specifics of technology or processes (which may be proprietary) until proposals are received.
- Requirements to effect safety not to be established without reasonable knowledge of the proposed approaches

General schedule for implementing both phases of TWRs Privatization

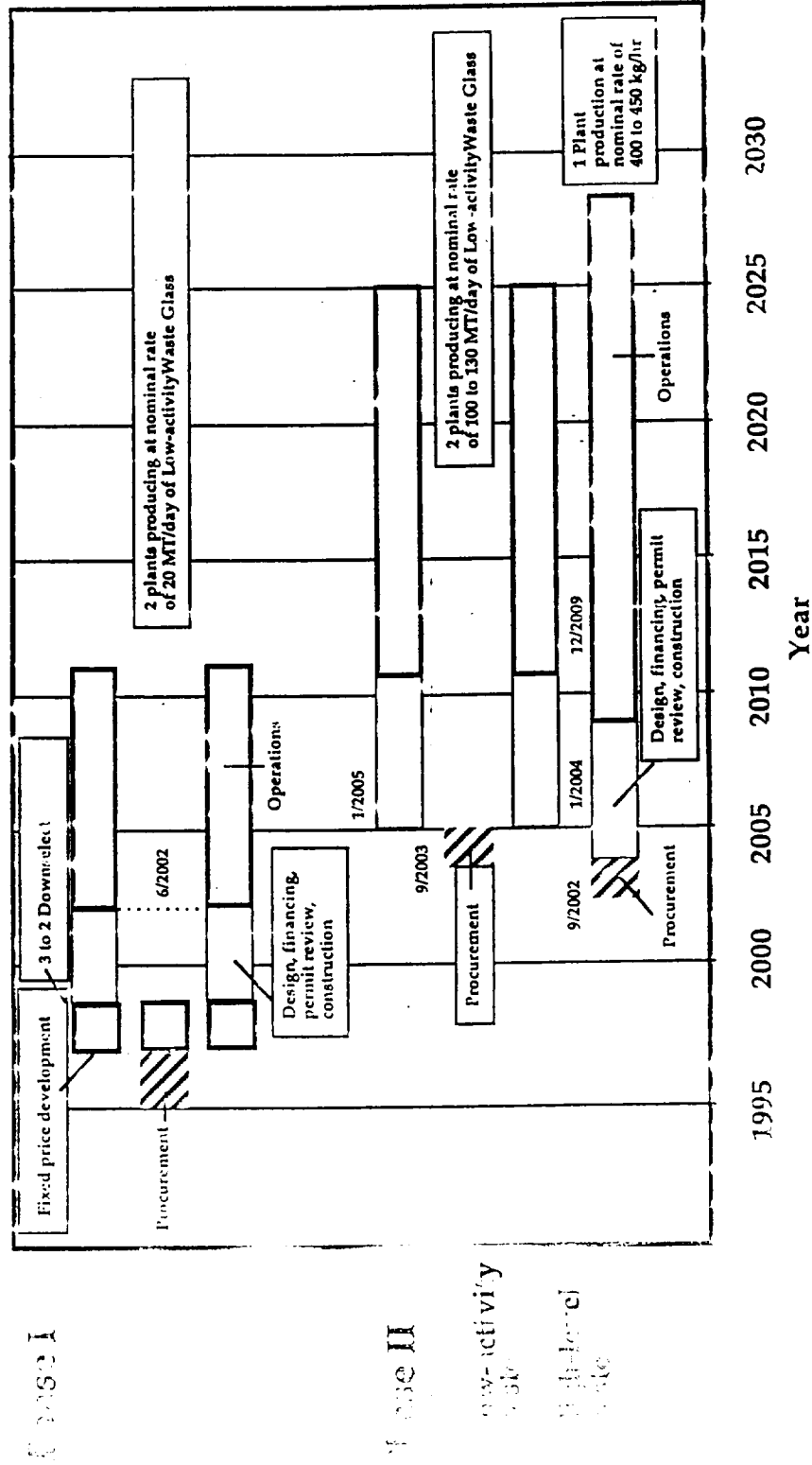

Radiological and Nuclear Safety

Regulatory Time Line

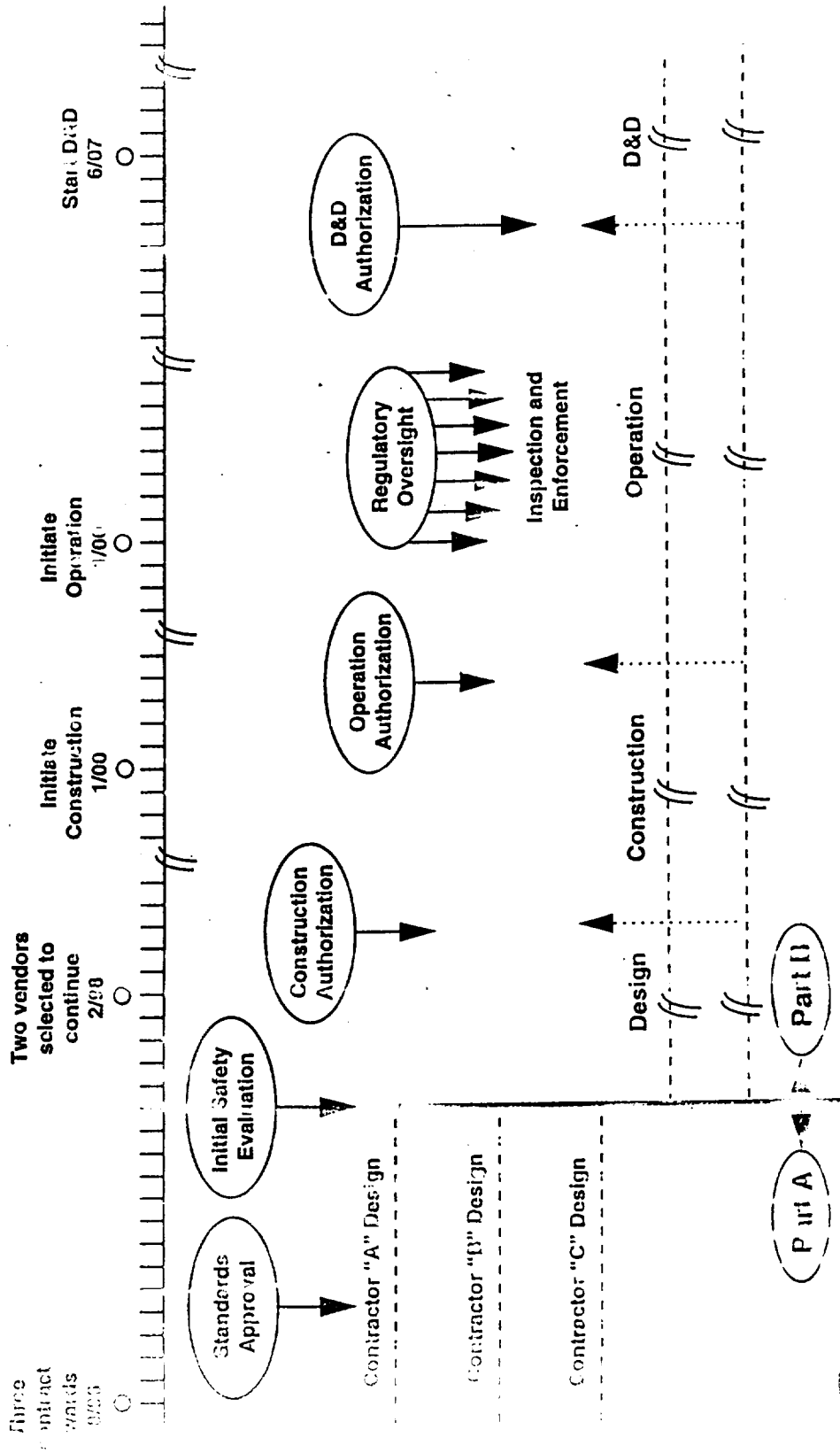

Radiological and Nuclear Safety

Regulatory Compliance Program Deliverables

Description of Regulatory Compliance Program Deliverable	Reference	Part A Deliverables	Part B Deliverables	
			Start of Construction	Start of Hot Operations
Process Facility Design Description	DOE/RL-DSRP Standard 2	Draft	Final	Revision
Integrated Standards-Based Safety Management Plan	DOE/RL-STDP DNFSB 95-2	Draft	Final	Final
Standards Analysis	DOE-STD-3009	Final	Revision 1	Revision 2
Standards and Requirements Identification Document	DOE/RL-STDP	Final	Final	Final
Radiation Exposure Standard for Workers Under Accident Conditions	DOE/RL-TLSK	Draft	Draft	Final
Quality Assurance Plan	10 CFR 830.120	Final	Final	Final
Training & Qualification Program Plan	10 CFR 830.330	Draft	Final	Rev. 1
Safety Analysis Report	10 CFR 830.110	Preliminary Draft	Preliminary Draft, Rev. 1	Final
Unreviewed Safety Questions Plan	10 CFR 830.112	Draft	Final	Final
Occurrence Reporting & Processing of Operating Information Plan	10 CFR 830.350	Draft	Final	Final
Contractor Occupational Medical Plan	DOE Order 440.1	---	Draft	Final
On-Site Transportation of Radioactive Materials Plan	DOE Order 460.1	Draft	Draft	Final
Employee Concerns Management System	DOE Order 5480.29	Final	Final	Final
Hazardous & Mixed Waste Handling Plan	DOE Order 5400.3	---	Final	Final

Radiological and Nuclear Safety

Regulatory Compliance Program Deliverables (continued)

Description of Regulatory Compliance Program	Reference	Part A Deliverables	Part B Deliverables	
			Start of Construction	Start of Hot Operations
RCRA Part B Permit Application	WAC 173-303-806	Final	Final Approved	---
NEPA C-2 Analysis (Supplement)	10 CFR 1021.314(c)	Draft	Final	---
Regular Operational Regulatory reports	DOE/RL-DSRP	Draft	Final	Final
Construction of Operations Plan	10 CFR 830.310	---	Final	Final
Technical Safety Requirements Document	10 CFR 830.320	Draft	Construction	Final
Maintenance Management Program Plan	10 CFR 830.340	---	Draft	Final
Operational Readiness Review Plan	DOE/RL-DSRP	---	Draft	Final
Backfit/Plant Modification Plan	DOE/RL-DSRP	Draft	Draft	Final
Emergency Response Plan	See Note 1 below	---	Final	Final
Safeguards and Security Plan	See Note 2 below	Draft	Draft	Final
Radionuclides and Hazardous Constituents Accountability Plan	See Note 3 below	---	Final	Final
Financial Viability for D&D	DOE/RL-DSRP	Draft	Final	Final
Decontamination & Decommissioning/RCRA	DOE/RL-DSRP	---	Final	Final
Closure/Site Restoration Plan				

1. Emergency Response Plan shall comply with requirements of 40 CFR 604.401, 40 CFR 355, and DOE/RL 94-02, Revision 1.
2. Safeguards and Security Plan shall comply with requirements contained in the Top-Level Safeguards and Security Requirements for TWBS Privatization (see Section 1).
3. Radionuclides and Hazardous Constituents Accountability Plan establishes the materials accountability basis for DOE to audit by weight and composition all radionuclide and hazardous constituents in the facility. This is the documentation of material balances to assure no release of radiological the hazardous constituents.

TWBS Privatization

DOE-NRC Discussion Regarding Support/Licensing of Privatized Facilities

<u>Date</u>	<u>Topic</u>
April 12, 1994	Discussion on approach to licensing potential ECA high-level waste vitrification plant
September 28, 1994	Informal discussion regarding possible NRC licensing of DOE "privatized" operations
March 6, 1995	Brief NRC staff on the status and present plans in privatization of TWRS facilities
May 11, 1995	Briefing on DOE approach to privatizing portions of the Tank Waste Remediation System

Estimates of Time to License and Permit

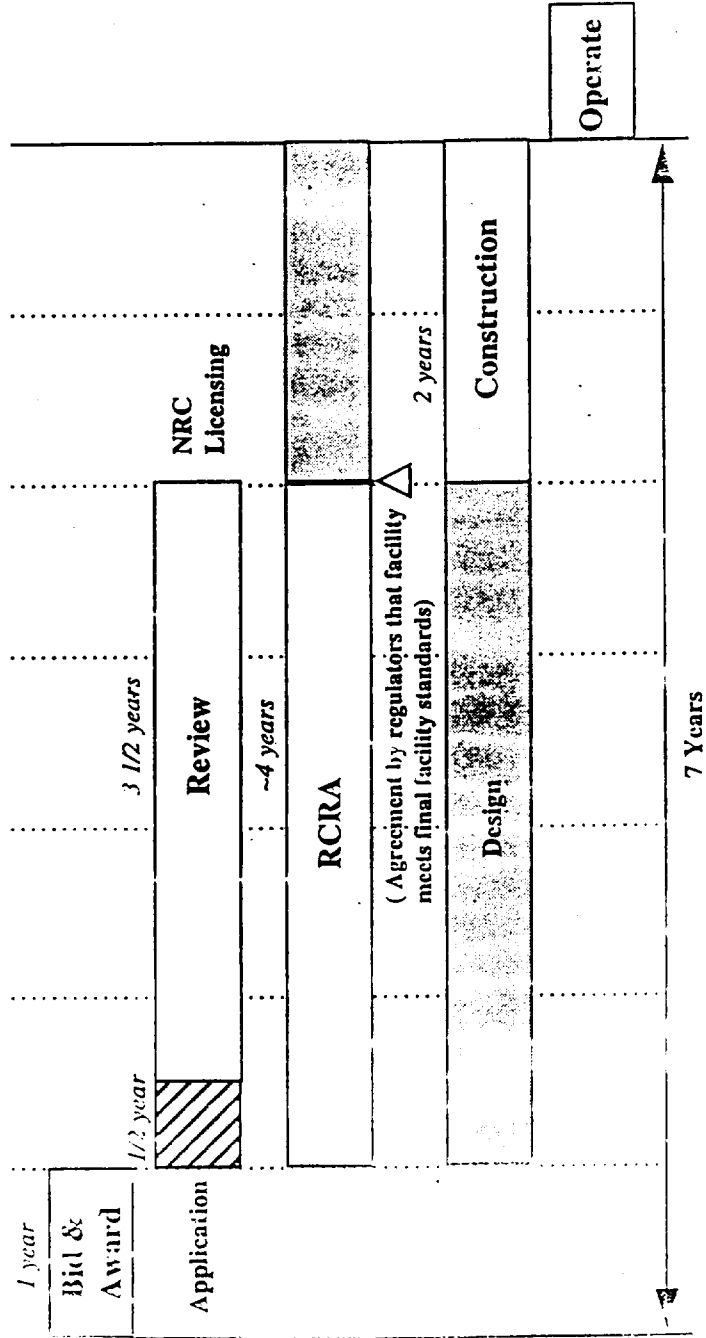

Estimates of Time to License and Permit

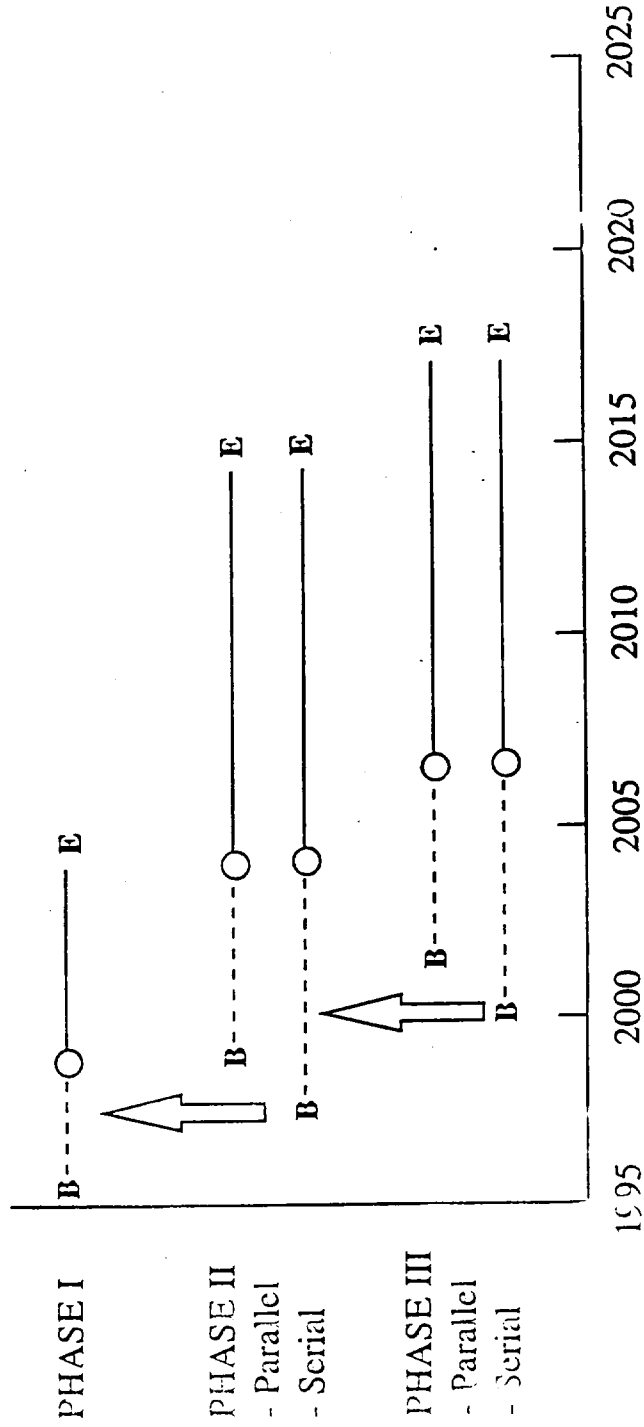

Radiological & Nuclear Safety Direction in RFP

- Section J** Explain the TWRS Privatization radiological and nuclear safety regulatory approach
- Section L** Explains for vendors information to be presented in proposal related to their capability in radiological and nuclear safety
- Section M** Outlines for vendors the evaluation factors used to evaluate their radiological and nuclear safety approach and capabilities presented in proposal
- Section C** Defines the deliverable under the contract that must be provided, including items important to radiological and nuclear safety (in a fixed-price contract everything has to be specified up front in the scope of work)



Radiological and Nuclear Safety Direction in RFP

- Section C Statement of Work - Standards for Deliverables Under the Contract
Standard 4: Regulatory Compliance Program
- Section H Special Contract Requirement
H-27 Radiological and Nuclear Safety Regulation (Stop Work)
- Section I Contract Clauses
I AR 952.250-7 Nuclear Hazards Indemnification Agreement (January 1992)
I DEAR 952.223-72 Radiation Protection and Nuclear Criticality (April 1994)
I DEAR 952-223.74 Nuclear Facility Safety Applicability (April 1994)
- Section J List of Documents, Exhibits, and Other Attachments
- Section L Instructions, Conditions, and Notices to Offerors
L-4 Proposal Preparation Instruction, Volume II, Past Performance,
Technical and Regulatory Proposal
- Section M Evaluation Factors
M.3 Technical Evaluation Factors

Section J: List of Documents, Exhibits, & Other Attachments

Documents which define proposed radiological and Nuclear Safety Regulatory Approach for TWRS Privatization Contractors

1. Concept of the DOE Regulatory Process for Radiological and Nuclear Safety for TWRS Privatization Contractors
2. Top-level Radiological and Nuclear Safety Standards and Principals for TWRS Privatization Contractors
3. Guide for establishing a Set for Essential Radiological and Nuclear Safety Standards and Requirements for TWRS Privatization
4. DOE Regulatory Process for Radiological and Nuclear Safety for TWRS Privatization Contractors

Section L: Instructions, Conditions, and Notices to Offerors

Safety Basis for Evaluating Contractor's Proposal

- Description of technology and processes
- Preliminary Hazard Analysis of processes and technology
- Strategy for mitigating hazardous conditions
- Basis for Integrated Standards-Based Safety Management Program
- Proposed standards for radiation protection of workers under accident conditions
- Draft Quality Assurance Plan

